

CORROSION INHIBITION EFFICIENCY AND ADSORPTION MECHANISM OF SOME SCHIFF BASES AT MILD STEEL/HCL INTERFACE

GHULAMULLAH KHAN¹, KAZI MD. SALIMNEWAZ², WAN JEFFREY BASIRUN³,
HAPIPAHBINTIMOHD ALI⁴, FADHILLAFTAFARAJ⁵ & MAGAJILADAN⁶

^{1,2}Department of Mechanical Engineering, Faculty of Engineering Building, University of Malaya,
50603 Kuala Lumpur, Malaysia

^{3,4,5,6}Department of Chemistry, Faculty of Science Building, University of Malaya, 50603 Kuala Lumpur, Malaysia

ABSTRACT

In this study, the inhibition effect of two Quinazolinone-Based compounds, namely, 2-(3, 3-Dimethyl-2, 3-dihydro-indol-2-ylidene)-3-[(2-hydroxyphenyl)-imino] propylidene and 2-(3, 3-Dimethyl-2, 3-dihydro-indol-2-ylidene)-3-[(2-hydroxyphenyl)-imino] propanal (LH₁ and LH₂, respectively), were investigated as potential corrosion inhibitors for mild steel in 1.0 M HCl solution. Various corrosion analysis methods were used, such as the gravimetric method, potentiodynamic polarization, electrochemical impedance spectroscopy (EIS) and scanning electron microscope (SEM). The results revealed that the inhibition efficiencies increased with an increase in HLs concentration having a mean efficiency of 92 % at 50 ppm in 1.0 M HCl. The obtained results showed that the inhibition efficiency of HL₁ was greater than HL₂ and that these obtained efficiencies from methods employed were in a good agreement. The polarization results revealed that the inhibitor decreased the corrosion current densities by means of a mixed mode mechanism. The SEM results indicated that the adsorption of the protective layer of the inhibitor on the metal/solution interface and obeyed Langmuir adsorption isotherm.

KEYWORDS: Metal, Corrosion, Electrochemical Methods, Schiff Bases, Surface Characteristics

INTRODUCTION

Organic compounds as corrosion inhibitors of iron, iron alloys, and steel have great significance due to the important applications of the metal [1-3]. Due to its low cost and excellent mechanical properties, mild steel is widely used as a construction material in automobiles, pipings, structures, fencing and in different applications in the chemical industry [4]. As the pipe performance of the equipment is severely affected by the presence of both scale and carrion products, researchers have focused on the corrosion inhibition of mild steel in acid solutions. Acids, particularly hydrochloric and sulphuric acids solutions are widely used for the pickling, descaling and cleaning of mild steel [5].

In order to retard the degree of metal dissolution and acid consumption, corrosion inhibitors are one of the most economical, practical and effective methods for the protection of metals against electrochemical corrosion [6,7]. The literature reveals that various organic compounds have been investigated in the terms of their effectiveness as corrosion inhibitors, including surfactants [8], bipyrazole derivatives [9], triazole derivatives [10], quinoxaline derivatives [11], organic dyes and drugs [12,13], aromatic hydrazides [14]. The inhibition results from the adsorption on the metal surface which blocks the active sites, thereby resulting in a decrease in the corrosion rate [15]. Research work reveals that the most well-known effective corrosion inhibitors for aluminium and steel are heterocyclic organic compounds. These

mainly comprises nitrogen, oxygen, phosphorous, sulphur atoms and multiple bonds in their molecular structure, which have usually effective inhibitors as they provide important features for the adsorption of inhibitor molecules on the metal substrate [16-19].

Among several organic compounds, some of the Schiff base compounds are extensively employed as excellent corrosion inhibitors for minimizing the corrosion of steel in acidic environments [20-22]. Some researchers reported that the presence of the –CN– group in Schiff base compounds enhances their adsorption activity and inhibition ability much greater than those containing amines and aldehydes [23]. A literature survey reveals that the Schiff base compounds that contain both nitrogen and sulphur are more effective corrosion inhibitors compared to those with only nitrogen or sulphur [26-27]. It is generally assumed that the inhibitor molecules are usually adsorbed on the metal surface by the electrostatic interaction between the charged centers of molecules and the charged metal surface. This results in a dipole interaction of the molecules and metal surface (physical adsorption) or by the transfer or shearing of electrons from the inhibitor to the metallic surface resulting in the formation of a co-ordinate covalent bond (chemical adsorption) in which the bonding strength is much larger than physical adsorption [28]. Several parameters, such as, the structural and electronic characteristics of the inhibitor, surface morphology, temperature, pressure, the flow velocity as well as the pH and composition of the aggressive environment depends on the adsorption process, and consequently, the inhibition efficiency and inhibition mechanism [29-32].

The objective of the present work is to investigate the corrosion behaviour and corrosion mechanism of mild steel in 1 M HCl solution at in the absence and presences of two newly synthesized Schiff base compounds (HL_s). Gravimetric measurements, electrochemical and scanning electron microscope (SEM) techniques were utilized to evaluate the corrosion inhibition efficiency of the investigated Schiff base compounds systemically.

EXPERIMENTAL METHODS

Preparation of Electrode

The working electrode was a commercial mild steel sheet with the following chemical composition of (wt %): C = 0.103, Si = 0.03, P = 0.021, Mn = 0.230, Al = 0.012, with the rest being Fe. The mild steel specimen was purchased from Power Hardware and Trading Sdn. Bhd, Kuala Lumpur, Malaysia. Steel samples of size 1 cm x 1.5 cm x 0.005 cm were mounted on a polyester base so that only 2.56 cm² of their cross-section area was exposed to the corrosive solution. The surfaces of the working electrodes were mechanically abraded using different grades of sand papers, 400, 600, 800, 1000, 1200 and 1500, prior to use. The electrodes were cleaned by washing with deionized water and degreased with ethanol respectively, and finally, dried with filter papers. For each test, a freshly abraded electrode was used. The HCl solution was prepared from analytical grade concentrated acid and deionized distilled water. All the tests were performed in a concentration range of 25– 100 ppm at room temperature.

Inhibitors

The Schiff base inhibitors were synthesized by the condensation reaction according to the published method [33]. The obtained products were purified by recrystallization from DMF solvent. The structural formula, abbreviations and IUPAC names of the synthesized Schiff base compounds are given in Table 1.

Table 1: The Chemical Structure and Abbreviation of HLs Schiff Base Inhibitors

Inhibitor	Abbreviation	Structure
2-(3,3-Dimethyl-2,3-dihydro-indol-2-ylidene)-3-[(2-hydroxyphenyl)imino]propylidene	LH ₁	
2-(3,3-Dimethyl-2,3-dihydro-indol-2-ylidene)-3-[(2-hydroxyphenyl)imino]propanal	LH ₂	

Weight Loss Measurements

Weight loss experiments were carried out using steel specimens with 1 cm x 1.5 cm x 0.005 cm dimensions. The series of steel specimens were abraded with different grades of emery paper, washed with distilled water, degreased with acetone, dried and kept in a desiccator. The specimens were accurately weighed and then immersed in 1 M HCl solution with and without the Schiff base. After 6 h exposure, the specimens were taken out, rinsed thoroughly with distilled water, dried and weighted accurately. The corrosion rate, surface coverage and inhibition efficiency were calculated using equations 1, 2 and 3, respectively.

$$C_R = \frac{\Delta W}{A \times t} \quad (1)$$

$$\Theta = \frac{C_R^0 - C_R}{C_R} \quad (2)$$

$$\eta_{WL}(\%) = \frac{C_R^0 - C_R}{C_R} \times 100 \quad (3)$$

Where ΔW is the average weight loss (mg), A is the available surface area of the specimen (cm^2), t is the immersion time (h), Θ is surface coverage, $\eta_{WL}(\%)$ is the weight loss efficiency and C_R^0 and $C_R(\text{mg}/\text{cm}^2 \cdot \text{h})$ are the corrosion rates in the absence and presence of the inhibitors, respectively.

Potentiodynamic Polarization Measurements

The electrochemical behavior of the MS sample in the absence and presence of an inhibitor was investigated using AUTOLAB (version 4.99) potentiostat/galvanostat. The experimental data were analysed utilizing a Pentium IV computer with GPES software, by recording the anodic and cathodic Tafel curves in 1.0 M HCl solutions with various inhibitor concentrations. A conventional three-electrode cell was employed, consisting of MS as the working electrode with an area of 2.56 cm^2 , a platinum auxiliary electrode and an Ag/AgCl reference. The working electrode was first immersed in the test solution for 30 seconds to establish a steady state open circuit potential (E_{ocp}).

Potentiodynamic polarization curves were obtained with a scan rate in the potential range between -800 to -250 mV at 5 mVs^{-1} . The linear Tafel segments of the anodic and cathodic curves were extrapolated to obtain the corrosion potential

(E_{corr}), and corrosion current density (i_{corr}). The $\eta_p(\%)$ at different inhibitors concentrations were calculated from the following Eq.

$$\eta_p(\%) = \frac{i_{corr}^0 - i_{corr}}{i_{corr}^0} \quad (4)$$

Where i_{corr}^0 and i_{corr} are uninhibited and inhibited corrosion current densities ($\mu\text{A}/\text{cm}^2$), respectively

Electrochemical Impedance Spectroscopy (EIS)

The impedance measurements were carried out at the open circuit potential (E_{ocp}), using a computer controlled potentiostat (autolab). The impedance data were analysed using a Pentium IV computer and FRA software. The alternating current frequency range was between 10^5 and 3×10^{-2} Hz, with a 5 mV sine wave as the excitation. The inhibition efficiency $\eta_{RP}(\%)$ was calculated from the polarization resistance, as shown in equation (5);

$$\eta_{RP}(\%) = \frac{R_p - R_p^0}{R_p} \times 100 \quad (5)$$

Where R_p and R_p^0 represents the polarization resistance for the inhibited and uninhibited solution, respectively

Surface Characterization

The steel specimens with 1 cm x 1.5 cm x 0.005 cm dimensions were immersed in 1.0 M HCl solution for 6 h in the absence and presence of the LHs inhibitor at 298 K. The specimens were removed and the surface morphological changes of the samples were investigated with a scanning electron microscope (SEM), using model Carl Zeiss LEO SUPRA 50 VP at an accelerating voltage of 15 KeV.

RESULTS AND DISCUSSIONS

Weight Loss Measurements

The values of corrosion rate (C_R), surface coverage (Θ), and $\eta_{WL}(\%)$ obtained from the weight loss measurements of mild steel after 6 h immersion in 1.0 M HCl solutions with and without the various concentrations of the Schiff base are summarized in table 2. The lone pair of electrons in the nitrogen atom and the presence of higher electron density in the inhibitor molecules co-ordinate with the active sites of the metal, and hence inhibit the corrosion process [25]. The data in Table 2 reveals that the corrosion rate of mild steel decreases with the addition of the Schiff base of the HLs, while the inhibition efficiency $\eta_{WL}(\%)$ and surface coverage (Θ) increase with the increase in inhibitor concentration. At a concentration of 100 ppm, the HL_1 and HL_2 Schiff bases exhibit maximum inhibition efficiency (94 % and 91%), respectively, at room temperature, which is due to efficient inhibition performance. This suggests that the inhibitor molecules act by the adsorption on the metal surface [18].

Table 2: Corrosion Inhibition Effect of LH_1 and LH_2 Obtained from the Weight Loss Measurements of Mild Steel after 6 h Immersion in 1 M HCl, Solution in the Absence and the Presence of the Schiff Bases at 298 K

Concentration (ppm)	LH_1			LH_2		
	A ($\mu\text{g cm}^{-2} \text{ h}^{-1}$)	θ	$\eta_{WL}(\%)$	A ($\mu\text{g cm}^{-2} \text{ h}^{-1}$)	θ	$\eta_{WL}(\%)$
Blank	5.66			5.5		
25	1.06	0.82	82	3.6	0.34	34
50	0.93	0.84	84	2.9	0.41	41
75	0.53	0.9	90	2.1	0.61	61
100	0.3	0.94	94	0.5	0.91	91

Potentiodynamic Polarization Measurements

Potentiodynamic polarization curves were recorded to investigate the corrosion inhibition effects of the green inhibitor on the electrochemical behaviour of MS in 1.0 M HCl. Figure 1 shows the anodic and cathodic polarization plots recorded on MS in 1 M HCl in the absence and presence of the LH₁ and LH₂ Schiff bases at different concentrations. The corrosion parameters, including corrosion potential (E_{corr}), corrosion current density (i_{corr}), anodic and cathodic Tafel slopes (b_a and b_c , respectively) and corrosion efficiency η_p (%) were derived from the polarization curves and summarized in table 3.

Table 3: Electrochemical Polarization Parameters and the Corresponding Inhibition Efficiency for Mild Steel in 1.0 M HCl Solution with and without Addition of the Schiff Base HLs at Different Concentrations

Inhibitors	Concentration (ppm)	- E_{corr} (mV vs. SCE)	b_a (V/dec)	b_c (V/dec)	i_{corr} ($\mu A cm^{-2}$)	η_p (%)
	Blank	0.634	0.161	0.192	543	-
	25	0.722	0.134	0.142	74	86
HL1	50	0.736	0.121	0.114	67	88
	75	0.758	0.118	0.112	51	90
	100	0.762	0.068	0.061	37	93
HL2	25	0.701	0.221	0.159	102	81
	50	0.623	0.196	0.139	70	87
	75	0.644	0.167	0.981	56	89
	100	0.656	0.121	0.251	47	91

Figure 1 shows that the presence of the LHs Schiff base inhibitors decreases both the anodic and cathodic slopes with the increase of inhibitor concentration. Generally, in acidic solutions the metal dissolution is the anodic process and hydrogen evolution or reduction of oxygen is the principal cathodic process. The cathodic Tafel curves suggest that the addition of LH_s does not modify the hydrogen evolution mechanism and the reduction of H⁺ at the MS surface which mainly occurs through a charge transfer mechanism. Firstly, the inhibitor molecules are adsorbed on the MS surface and block all the available reaction sites. Hence, the available surface for the reaction of H⁺ ions decreases, and as a result, the actual reaction mechanism stands unaffected [34].

It must be noted from table 3 that, when the concentration of the corrosion inhibitor increases the corrosion current density decreases, while the inhibition efficiency increases, and the corrosion potential with the LHs inhibitors shifts towards a cathodic potential. These results suggest that the LHs are a mixed type inhibitor, with predominant cathodic effectiveness in the HCl medium. The obtained results are in a good agreement with those obtained from impedance measurements.

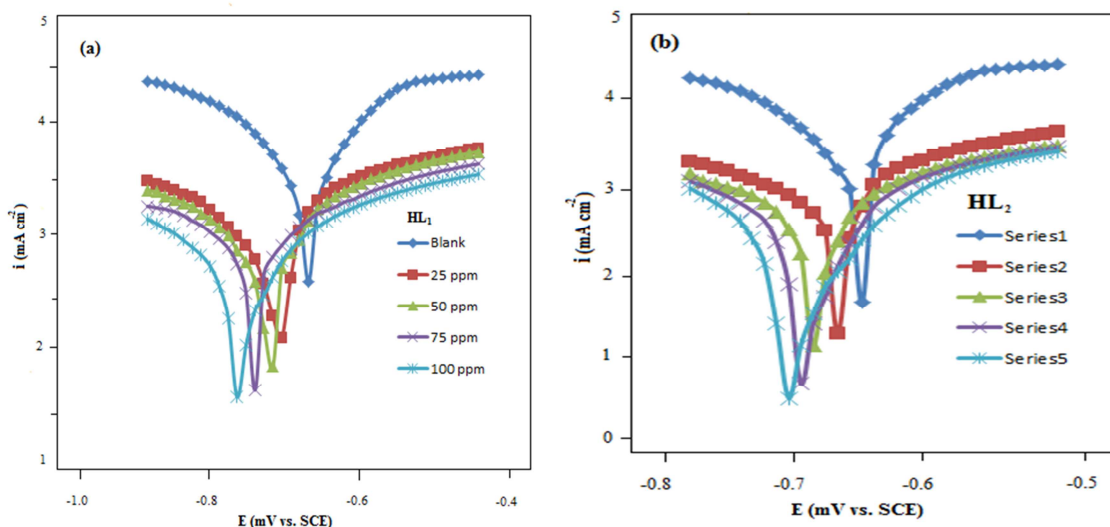

Figure 1: Potentiodynamic Polarization Curves for MS in 1 M HCl Solution Containing Different Concentrations of (a) HL₁ and (b) HL₂

Electrochemical Impedance Spectroscopy Measurements

Electrochemical Impedance Spectroscopy is a powerful tool for a detailed investigation of the electrode kinetics and surface properties of the system under study. The analysis of the different shapes of the impedance diagram provides a basis for the mechanistic approach [35]. Figure 3 presents the Nyquist plots of MS in uninhibited and inhibited acidic solution with various concentrations of Schiff base compounds of LH₁ and LH₂, respectively.

The existence of a single semicircle shows a single charge transfer process during the dissolution, and it is important to note that the changes in the concentration of Schiff base inhibitors did not alter the impedance mechanism, which suggests a similar mechanism for the corrosion inhibition of mild steel by the Schiff base compounds. Figure 4 and Fig 5 shows that the Nyquist plots do not yield a perfect semicircle as expected but rather a depressed semicircle due to the frequency dispersion of interfacial impedance, which arises due to the surface roughness, impurities, dislocations, grain boundaries, adsorption of inhibitors, and the formation of the porous layers and homogenous electrode surface [36,37]. The fitted values for polarization resistance (R_p), constant phase element (CPE) and the inhibitor efficiency η_{RP} (%), are illustrated in table 4.

Table 4: Electrochemical Impedance Parameters of Mild Steel in 1 M HCl Solution in the Absence and Presence of Different Concentrations of HLs at Room Temperature

Inhibitor	Concentration (ppm)	CPE (10^{-4}) (F)	n	R_p (Ω)	η_z (%)
	Blank	7.89	0.87	11.63	-
HL ₁	25	6.29	0.82	55.14	78
	50	5.81	0.66	58.07	80
	75	5.35	0.79	75.04	84
	100	4.73	0.67	153.67	92
HL ₂	25	5.8	0.68	31.94	67
	50	3.31	0.66	50.08	76
	75	3.11	0.65	61.17	80
	100	2.95	0.64	122.22	90

The results obtained from EIS were fitted according to the electrical equivalent circuit diagram shown in Figure 2, in which CPE is the constant phase element and n is the phase shift which can be explained as a degree of the surface inhomogeneity [38,39]. CPE is commonly used instead of double layer capacitance (C_{dl}) to achieve a more accurate fit to the experimental results [40].

Figure 2 show that the impedance behaviour of mild steel in 1 M HCl presents a marked change in the impedance response for the concentrations of LHs. It is important to note that the impedance profiles did not alter with the change in concentration, which suggests a similar corrosion inhibition mechanism on the mild steel surface. The addition of Schiff base to the aggressive solution results in an increase in the diameter of the semicircle. This enhancement becomes more and more altered with the increase in the inhibitor concentration.

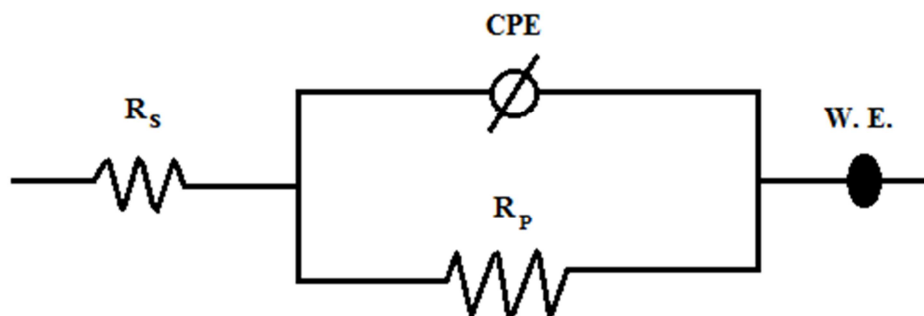

Figure 2: An Electrical Equivalent Circuit Diagram for the Modeling of Mild Steel/Solution Interface

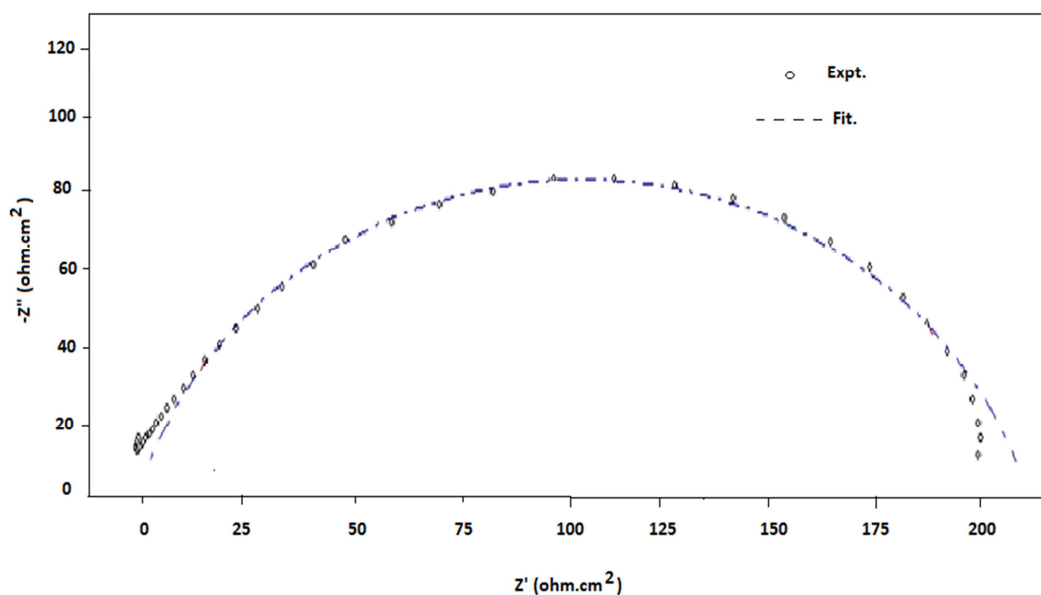

Figure 3: EIS-Fitted Data for HLs in 1 M HCl Solution Using the Equivalent Circuit Model Diagram in Figure 2

From table 4, it was found that the R_p values increases and the CPE values decreases with the increase in the inhibitor concentration. The increase in R_p values suggests the formation of a protective film at the metal/solution interface. Moreover, the decrease in CPE is due to the decrease in the local dielectric constant and/or an increase in the thickness of the electrical double layer at electrode surface, therefore enhancing corrosion resistance of mild steel. The decrease in the CPE values is related to the gradual replacement of water molecules by the inhibitor molecules on the mild steel surface, and decreases the number of active sites necessary for the corrosion reaction [41]. The increase in the inhibitor

concentration increase R_p but decreases CPE, which suggests that the LHs Schiff base acts as a primary interface inhibitor and controls the corrosion charge transfer of mild steel under open circuit conditions. Figure 2 suggests that the Nyquist plot shows a depressed semicircle instead of perfect semicircles. This deviation may be attributed to the frequency dispersion of the interfacial impedance. This anomalous phenomenon is due to the inhomogeneous electrode surface arising from the surface roughness or interfacial phenomena [27-29]. The impedance results show a good correlation as found in both Tafel polarization and weight loss methods.

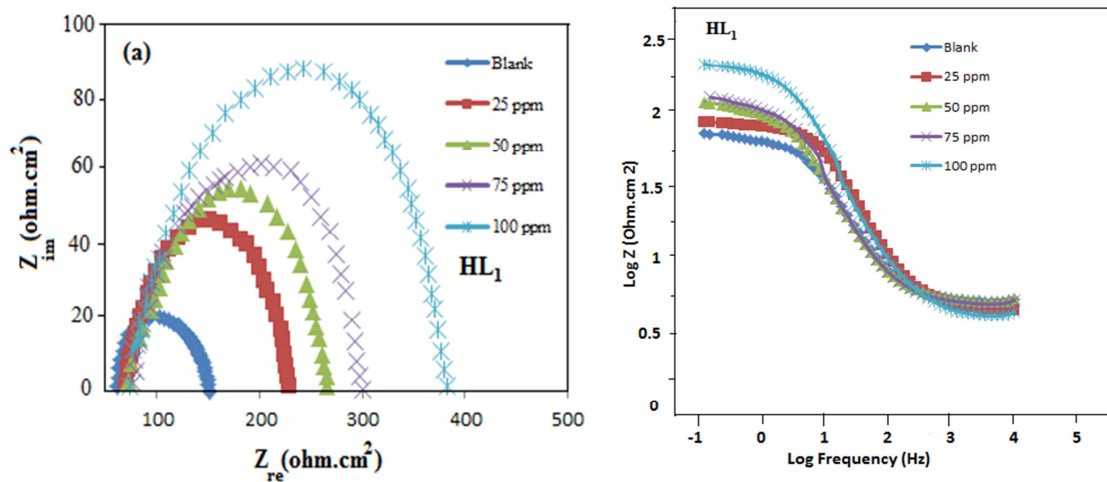

Figure 4: The Nyquist and (Log Freq) – (Log z) Plots for Mild Steel in 1.0 M HCl Solution with the Presence of the Corrosion Inhibitors for HL₁ at Room Temperature

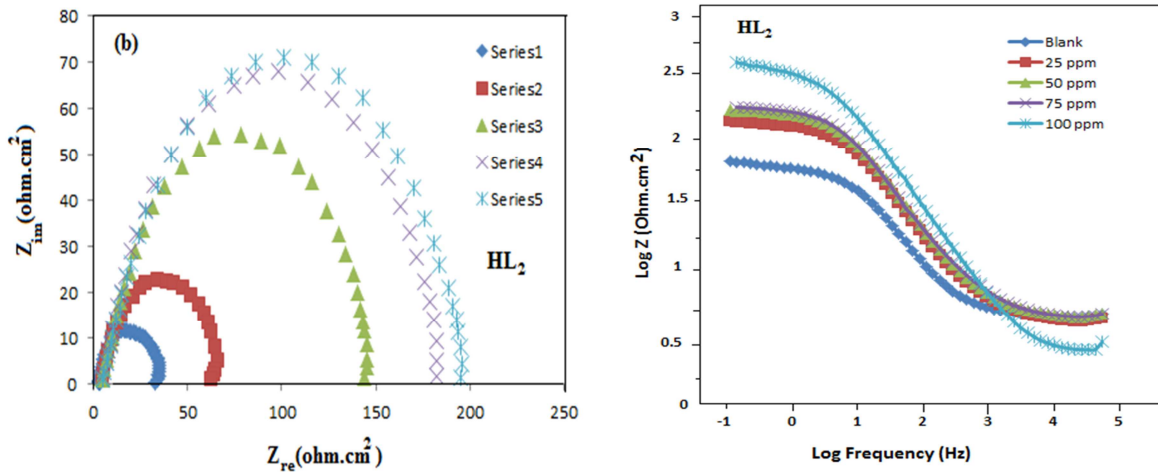

Figure 5: The Nyquist and (Log Freq) – (Log z) plots for Mild Steel in 1.0 M HCl Solution with the Presence of the Corrosion Inhibitors for HL₂ at Room Temperature

ADSORPTION ISOTHERM

The interaction of the inhibitor molecule with the active sites on the metal surface can be explained from the adsorption isotherms [42]. Various isotherms, such as the Freundlich, Temkin, Foly-Huggins and Langmuir [43-45], have been tested but the best fit was achieved with the Langmuir isotherm for the Schiff base on mild steel. The Langmuir isotherm is presented by equation (7), [42]:

$$\frac{c}{\theta} = \frac{1}{K_{ads}} + c \tag{7}$$

Where K_{ads} is the equilibrium constant of the adsorption process, denoting the interaction of the inhibitor with the metal surface, θ is the surface coverage and C is the inhibitor concentration. The linear relationship of C/θ versus θ in Figure 6, having the values of correlation coefficient of (0.99 and 0.97) which are close to unity, suggests that the adsorption of HLs on MS surface in 1.0 M HCl acid solution obeys Langmuir adsorption. This model assumes that the solid surface contains a fixed number of adsorption sites and that each site holds one adsorbed species [3]. The constant K_{ads} is related to the standard free energy of adsorption ΔG_{ads}^0 by the following equation(8):

$$\Delta G_{ads}^0 = -RT \ln(55.5 K_{ads}) \quad (8)$$

Where R is the universal gas constant $8.3142 \text{ JK}^{-1}\text{mol}^{-1}$, and T is the temperature in Kelvin. The value of 55.5 is the concentration of the water in the solution in moles per liter [46]. The large negative values of ΔG_{ads}^0 indicate a spontaneous adsorption process, as well as the stability of the adsorbed inhibitor layer on the solid surface [47]. In addition the negative value of ΔG_{ads}^0 represents a strong interaction between the HLs molecules and mild steel surface. [48]. Literature review suggests that the values of ΔG_{ads}^0 around -20 kJ mol^{-1} or lower (more positive) are consistent with a physisorption (electrostatic interaction between inhibitor molecules and metal) phenomenon, while those around or higher (more negative) than -40 kJ mol^{-1} demonstrates the charge shearing between the adsorbent and adsorbate (chemisorption) [49,50]. The calculated values of ΔG_{ads}^0 for investigated inhibitor, HL₁ and HL₂ are -34.03 and 33.32 kJ/mol , respectively as listed in table 5, which suggests that the adsorption mechanism of these inhibitors on mild steel surface in 1.0 M HCl solution involve a complex combination of both physical and chemical adsorption [51].

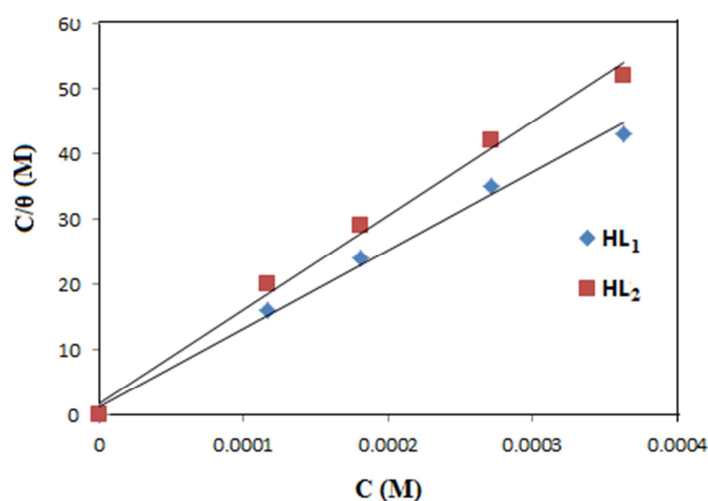

Figure 6: Langmuir Adsorption Plots of Mild Steel in 1 M HCl with Various HLs Concentrations

Generally, it is expected that both protonated and non-protonated species of HLs could exist in acidic medium. As a result of electrostatic attraction, there may be the adsorption of the cationic species on the cathodic sites of the MS and reducing hydrogen evolution, hence shielding the cathodic sites of steel surface. Increasing the inhibitor concentration may increase the protonated species on metallic surface [52], thereby a decrease in the cathodic currents and limits the decrease in the anodic currents as well.

Table 5: Langmuir Adsorption Isotherm Parameters of Inhibitors for MS in 1 M HCl at 298 K

Inhibitors	K_{ads} (M^{-1})	ΔG_{ads} ($kJmol^{-1}$)	R^2
HL1	16.66×103	-34.03	0.99
HL2	12.50×103	-33.32	0.99

Scanning Electron Microscope (SEM) Measurements

The SEM analysis of the electrode surface provides the effect of the Schiff base on the corrosion process of MS. Figure 7 represents an array of SEM images of the abraded mild steel surfaces exposed for 6 h in 1 M HCl solutions with and without inhibitors at the maximum concentration of 50 ppm at room temperature. Figure 7 (b) represents the SEM examination of MS sample in uninhibited HCl solution. This image strongly suggests that the metal surface was severely damaged in the absence of inhibitor, and resulted in the metal dissolution in acidic solution. While Figure 7(c-d) shows that the presence of the inhibitor decreased the damaged of metal surface, where the corrosion rate was suppressed due to the formation of a more compact protective film by the adsorption of the HLs compounds on the surface of the sample.

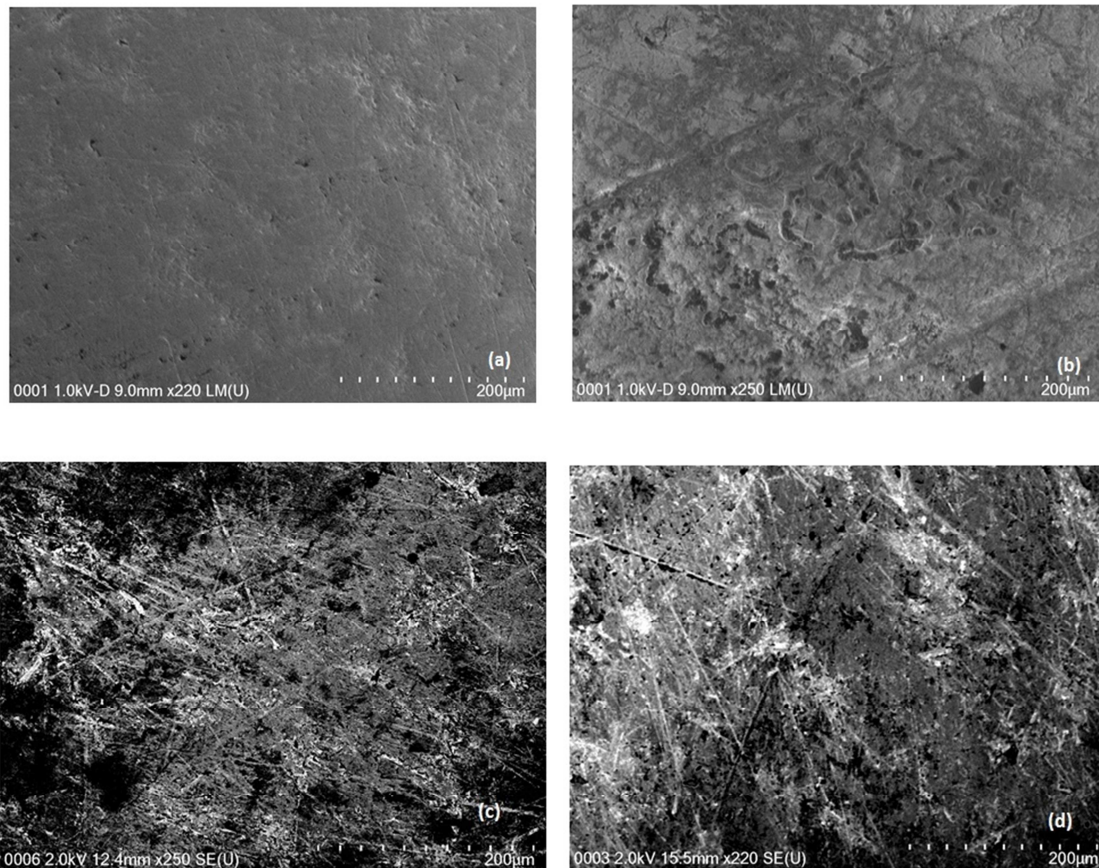

Figure 7: SEM Micrographs of Mild Steel Surfaces (a) Abraded Mild Steel (b) un Inhibited 1.0 M HCl (c) 50 ppm of LH₁(d) 50 ppm of LH₂

CONCLUSIONS

The corrosion inhibition efficiency of the LHs Schiff base on MS in 1 M HCl was studied by polarization, impedance and SEM analysis. Both LHs showed good inhibition properties with the formation of a compact protective film,

and adsorption on the metal surface, there by obeying the Langmuir adsorption isotherm. The inhibition efficiency values of LH₁ are higher than that of LH₂, and increases with the increase in the inhibitor concentration. The polarization curves results indicate that both inhibitors act as a mixed type inhibitor by inhibiting the anodic metal dissolution and cathodic hydrogen evolution reactions by simply blocking the active metal sites, i.e. the addition of the inhibitor did not change the corrosion mechanism of mild steel in 1 M HCl medium. The EIS results reveal that the double layer capacitance decreased and the charge transfer resistance when the inhibitor concentration was increased. All results obtained from the polarization, EIS and weight loss experiments are in good agreement, with a slight deviation in numerical values. Surface morphology reveals the formation of a protective and dense film on the mild steel surface as a result of the addition of inhibitor in the aggressive solution.

ACKNOWLEDGEMENTS

This research is supported by high impact research grants no. UM.C/HIR/HOME/SC/09 (HIR Grant F000009-21001) and (PG015-2013A and PG084-2013A), Ministry of Higher Education Malaysia.

REFERENCES

1. F Bentiss, M Lagrenee, and M Traisnel, '2, 5-Bis (N-Pyridyl)-1, 3, 4-Oxadiazoles as Corrosion Inhibitors for Mild Steel in Acidic Media', *Corrosion*, 56 (2000), 733-42.
2. AA Atia, and MM Saleh, 'Inhibition of Acid Corrosion of Steel Using Cetylpyridinium Chloride', *Journal of applied electrochemistry*, 33 (2003), 171-77.
3. M Tariq Saeed, Sk Asrof Ali, and SU Rahman, 'The Cyclic Hydroxylamines: A New Class of Corrosion Inhibitors of Carbon Steel in Acidic Medium', *Anti-Corrosion Methods and Materials*, 50 (2003), 201-07.
4. M Shyamala, and PK Kasthuri, 'The Inhibitory Action of the Extracts of Adathoda Vasica, Eclipta Alba, and Centella Asiatica on the Corrosion of Mild Steel in Hydrochloric Acid Medium: A Comparative Study', *International Journal of Corrosion*, 2012 (2011).
5. Fatma Kandemirli, and Seda Sagdinc, 'Theoretical Study of Corrosion Inhibition of Amides and Thiosemicarbazones', *Corrosion science*, 49 (2007), 2118-30.
6. CB Pradeep Kumar, and KN Mohana, 'Corrosion Inhibition Efficiency and Adsorption Characteristics of Some Schiff Bases at Mild Steel/Hydrochloric Acid Interface', *Journal of the Taiwan Institute of Chemical Engineers*, 45 (2014), 1031-42.
7. AY El-Etre, 'Inhibition of Aluminum Corrosion Using Opuntia Extract', *Corrosion science*, 45 (2003), 2485-95.
8. AS Algaber, Eman M El-Nemma, and Mahmoud M Saleh, 'Effect of Octylphenol Polyethylene Oxide on the Corrosion Inhibition of Steel in 0.5 M H₂SO₄', *Materials chemistry and physics*, 86 (2004), 26-32.
9. H Zarrok, H Oudda, A El Midaoui, A Zarrouk, B Hammouti, M Ebn Touhami, A Attayibat, S Radi, and R Touzani, 'Some New Bipyrazole Derivatives as Corrosion Inhibitors for C38 Steel in Acidic Medium', *Research on Chemical Intermediates*, 38 (2012), 2051-63.
10. AY Musa, AAH Kadhum, AB Mohamad, MS Takriff, AR Daud, and SK Kamarudin, 'Adsorption Isotherm Mechanism of Amino Organic Compounds as Mild Steel Corrosion Inhibitors by Electrochemical Measurement

- Method', *Journal of Central South University of Technology*, 17 (2010), 34-39.
11. K Adardour, R Touir, Y Ramli, RA Belakhmima, M Ebn Touhami, C Kalonji Mubengayi, H El Kafsaoui, and EM Essassi, 'Comparative Inhibition Study of Mild Steel Corrosion in Hydrochloric Acid by New Class Synthesised Quinoxaline Derivatives: Part I', *Research on Chemical Intermediates*, 39 (2013), 1843-55.
 12. [MM El-Naggar, 'Corrosion Inhibition of Mild Steel in Acidic Medium by Some Sulfa Drugs Compounds', *Corrosion Science*, 49 (2007), 2226-36.
 13. EE Ebenso, Hailemicheal Alemu, SA Umoren, and IB Obot, 'Inhibition of Mild Steel Corrosion in Sulphuric Acid Using Alizarin Yellow Gg Dye and Synergistic Iodide Additive', *International Journal of Electrochemical Science*, 3 (2008), 1325-39.
 14. MA Quraishi, Rana Sardar, and Danish Jamal, 'Corrosion Inhibition of Mild Steel in Hydrochloric Acid by Some Aromatic Hydrazides', *Materials chemistry and physics*, 71 (2001), 309-13.
 15. F Bentiss, M Traisnel, N Chaibi, B Mernari, H Vezin, and M Lagrenée, '2, 5-Bis (N-Methoxyphenyl)-1, 3, 4-Oxadiazoles Used as Corrosion Inhibitors in Acidic Media: Correlation between Inhibition Efficiency and Chemical Structure', *Corrosion science*, 44 (2002), 2271-89.
 16. M El Achouri, S Kertit, HM Gouttaya, B Nciri, Y Bensouda, L Perez, MR Infante, and K Elkacemi, 'Corrosion Inhibition of Iron in 1 M Hcl by Some Gemini Surfactants in the Series of Alkanediyl-A, Ω -Bis-(Dimethyl Tetradecyl Ammonium Bromide)', *Progress in Organic Coatings*, 43 (2001), 267-73.
 17. SA Abd El-Maksoud, 'Studies on the Effect of Pyranocoumarin Derivatives on the Corrosion of Iron in 0.5 M Hcl', *Corrosion science*, 44 (2002), 803-13.
 18. M Abdallah, 'Rhodanine Azosulpha Drugs as Corrosion Inhibitors for Corrosion of 304 Stainless Steel in Hydrochloric Acid Solution', *Corrosion science*, 44 (2002), 717-28.
 19. KF Khaled, 'The Inhibition of Benzimidazole Derivatives on Corrosion of Iron in 1 M Hcl Solutions', *Electrochimica Acta*, 48 (2003), 2493-503.
 20. Kaan C Emregül, and Mustafa Hayvalı, 'Studies on the Effect of a Newly Synthesized Schiff Base Compound from Phenazone and Vanillin on the Corrosion of Steel in 2m Hcl', *Corrosion science*, 48 (2006), 797-812.
 21. MG Hosseini, M Ehteshamzadeh, and T Shahrabi, 'Protection of Mild Steel Corrosion with Schiff Bases in 0.5 Mh 2 So 4 Solution', *Electrochimica acta*, 52 (2007), 3680-85.
 22. Ramazan Solmaz, Ece Altunbaş, and Gülfeza Kardaş, 'Adsorption and Corrosion Inhibition Effect of 2-((5-Mercapto-1, 3, 4-Thiadiazol-2-Ylimino) Methyl) Phenol Schiff Base on Mild Steel', *Materials Chemistry and Physics*, 125 (2011), 796-801.
 23. Shulan Li, Shenhao Chen, Shengbin Lei, Houyi Ma, Rui Yu, and Dexin Liu, 'Investigation on Some Schiff Bases as Hcl Corrosioninhibitors for Copper', *Corrosion science*, 41 (1999), 1273-87.
 24. Ramazan Solmaz, Ece Altunbaş, and Gülfeza Kardaş, 'Adsorption and Corrosion Inhibition Effect of 2-((5-Mercapto-1, 3, 4-Thiadiazol-2-Ylimino) Methyl) Phenol Schiff Base on Mild Steel', *Materials Chemistry*

- and Physics*, 125 (2011), 796-801.
25. Shulan Li, Shenhao Chen, Shengbin Lei, Houyi Ma, Rui Yu, and Dexin Liu, 'Investigation on Some Schiff Bases as Hcl Corrosioninhibitors for Copper', *Corrosion science*, 41 (1999), 1273-87.
 26. J Aljourani, MA Golozar, and K Raeissi, 'The Inhibition of Carbon Steel Corrosion in Hydrochloric and Sulfuric Acid Media Using Some Benzimidazole Derivatives', *Materials Chemistry and Physics*, 121 (2010), 320-25.
 27. Rovshan Hasanov, Selen Bilge, Semra Bilgiç, Gökhan Gece, and Zeynel Kılıç, 'Experimental and Theoretical Calculations on Corrosion Inhibition of Steel in 1m H₂ So 4 by Crown Type Polyethers', *Corrosion Science*, 52 (2010), 984-90.
 28. Fengling Xu, Jizhou Duan, Shufang Zhang, and Baorong Hou, 'The Inhibition of Mild Steel Corrosion in 1 M Hydrochloric Acid Solutions by Triazole Derivative', *Materials Letters*, 62 (2008), 4072-74.
 29. Pierre R Roberge, *Corrosion Inspection and Monitoring*. Vol. 2 (John Wiley & Sons, 2007).
 30. M Heydari, and M Javidi, 'Corrosion Inhibition and Adsorption Behaviour of an Amido-Imidazoline Derivative on Api 5l X52 Steel in Co 2-Saturated Solution and Synergistic Effect of Iodide Ions', *Corrosion Science*, 61 (2012), 148-55.
 31. X Jiang, YG Zheng, and W Ke, 'Effect of Flow Velocity and Entrained Sand on Inhibition Performances of Two Inhibitors for Co 2 Corrosion of N80 Steel in 3% Nacl Solution', *Corrosion Science*, 47 (2005), 2636-58.
 32. Armando Garnica-Rodriguez, J Genesca, Juan Mendoza-Flores, and Ruben Duran-Romero, 'Electrochemical Evaluation of Aminotriazole Corrosion Inhibitor under Flow Conditions', *Journal of applied electrochemistry*, 39 (2009), 1809-19.
 33. Fadhil Lafta Faraj, Maryam Zahedifard, Mohammadjavad Paydar, Chung Yeng Looi, Nazia Abdul Majid, Hapipah Mohd Ali, Noraini Ahmad, Nura Suleiman Gwaram, and Mahmood Ameen Abdulla, 'Synthesis, Characterization, and Anticancer Activity of New Quinazoline Derivatives against MCF-7 Cells', *The Scientific World Journal*, 2014 (2014).
 34. IB Obot, and NO Obi-Egbedi, 'Anti-Corrosive Properties of Xanthone on Mild Steel Corrosion in Sulphuric Acid: Experimental and Theoretical Investigations', *Current Applied Physics*, 11 (2011), 382-92.
 35. Ali Döner, Ece Altunbaş Şahin, Gülfeza Kardaş, and Osman Serindağ, 'Investigation of Corrosion Inhibition Effect of 3-[(2-Hydroxy-Benzylidene)-Amino]-2-Thioxo-Thiazolidin-4-One on Corrosion of Mild Steel in the Acidic Medium', *Corrosion Science*, 66 (2013), 278-84.
 36. A Popova, E Sokolova, S Raicheva, and Mz Christov, 'Ac and Dc Study of the Temperature Effect on Mild Steel Corrosion in Acid Media in the Presence of Benzimidazole Derivatives', *Corrosion Science*, 45 (2003), 33-58.
 37. J Aljourani, K Raeissi, and MA Golozar, 'Benzimidazole and Its Derivatives as Corrosion Inhibitors for Mild Steel in 1m Hcl Solution', *Corrosion science*, 51 (2009), 1836-43.
 38. O Benali, L Larabi, M Traisnel, L Gengembre, and Y Harek, 'Electrochemical, Theoretical and Xps Studies of 2-Mercapto-1-Methylimidazole Adsorption on Carbon Steel in 1m Hclo 4', *Applied surface science*, 253 (2007),

- 6130-39.
39. Muzaffer Özcan, Faruk Karadağ, and Ilyas Dehri, 'Investigation of Adsorption Characteristics of Methionine at Mild Steel/Sulfuric Acid Interface: An Experimental and Theoretical Study', *Colloids and Surfaces A: Physicochemical and Engineering Aspects*, 316 (2008), 55-61.
 40. M Behpour, SM Ghoreishi, N Soltani, and M Salavati-Niasari, 'The Inhibitive Effect of Some Bis-N, S-Bidentate Schiff Bases on Corrosion Behaviour of 304 Stainless Steel in Hydrochloric Acid Solution', *Corrosion Science*, 51 (2009), 1073-82.
 41. EE Oguzie, Y Li, and FH Wang, 'Corrosion Inhibition and Adsorption Behavior of Methionine on Mild Steel in Sulfuric Acid and Synergistic Effect of Iodide Ion', *Journal of colloid and interface science*, 310 (2007), 90-944].
 42. Peter C Okafor, and Yugui Zheng, 'Synergistic Inhibition Behaviour of Methylbenzyl Quaternary Imidazoline Derivative and Iodide Ions on Mild Steel in H₂SO₄ Solutions', *Corrosion Science*, 51 (2009), 850-59.
 43. IB Obot, and NO Obi-Egbedi, 'Inhibition of Aluminium Corrosion in Hydrochloric Acid Using Nizoral and the Effect of Iodide Ion Addition', *Journal of Chemistry*, 7 (2010), 837-43.
 44. Paul J Flory, 'Thermodynamics of High Polymer Solutions', *The Journal of chemical physics*, 10 (1942), 51-61.
 45. E Machnikova, Kenton H Whitmire, and N Hackerman, 'Corrosion Inhibition of Carbon Steel in Hydrochloric Acid by Furan Derivatives', *Electrochimica Acta*, 53 (2008), 6024-32.
 46. Libin Tang, Xueming Li, Lin Li, Guannan Mu, and Guangheng Liu, 'The Effect of 1-(2-Pyridylazo)-2-Naphthol on the Corrosion of Cold Rolled Steel in Acid Media: Part 2: Inhibitive Action in 0.5 M Sulfuric Acid', *Materials chemistry and physics*, 97 (2006), 301-07.
 47. Libin Tang, Xueming Li, Lin Li, Guannan Mu, and Guangheng Liu, 'The Effect of 1-(2-Pyridylazo)-2-Naphthol on the Corrosion of Cold Rolled Steel in Acid Media: Part 2: Inhibitive Action in 0.5 M Sulfuric Acid', *Materials chemistry and physics*, 97 (2006), 301-07.
 48. Guannan Mu, Xueming Li, and Guangheng Liu, 'Synergistic Inhibition between Tween 60 and NaCl on the Corrosion of Cold Rolled Steel in 0.5 M Sulfuric Acid', *Corrosion Science*, 47 (2005), 1932-52.
 49. Serpil Şafak, Berrin Duran, Aysel Yurt, and Gülşen Türkoğlu, 'Schiff Bases as Corrosion Inhibitor for Aluminium in HCl Solution', *Corrosion Science*, 54 (2012), 251-59.
 50. A Ali, HA Al-Muallem, SU Rahman, and MT Saeed, 'Bis-Isoxazolidines: A New Class of Corrosion Inhibitors of Mild Steel in Acidic Media', *Corrosion Science*, 50 (2008), 3070-77.